

SIEMENS

SITRANS L

Rotating Paddle Switch SITRANS LPS200

Operating Instructions



<u>Introduction</u>	1
<u>Safety notes</u>	2
<u>Description</u>	3
<u>Applications</u>	4
<u>Installing/mounting</u>	5
<u>Connection</u>	6
<u>Service and maintenance</u>	7
<u>Technical data</u>	8
<u>Dimension drawings</u>	9
<u>Technical reference</u>	A
<u>Certificates and support</u>	B

7ML5725-.....-....., 7ML5726-.....-....., 7ML5727-.....-.....,
7ML5728-.....-....., 7ML5730-.....-.....

Legal information

Warning notice system

This manual contains notices you have to observe in order to ensure your personal safety, as well as to prevent damage to property. The notices referring to your personal safety are highlighted in the manual by a safety alert symbol, notices referring only to property damage have no safety alert symbol. These notices shown below are graded according to the degree of danger.

 DANGER
indicates that death or severe personal injury will result if proper precautions are not taken.
 WARNING
indicates that death or severe personal injury may result if proper precautions are not taken.
 CAUTION
indicates that minor personal injury can result if proper precautions are not taken.
NOTICE
indicates that property damage can result if proper precautions are not taken.

If more than one degree of danger is present, the warning notice representing the highest degree of danger will be used. A notice warning of injury to persons with a safety alert symbol may also include a warning relating to property damage.

Qualified Personnel

The product/system described in this documentation may be operated only by **personnel qualified** for the specific task in accordance with the relevant documentation, in particular its warning notices and safety instructions. Qualified personnel are those who, based on their training and experience, are capable of identifying risks and avoiding potential hazards when working with these products/systems.

Proper use of Siemens products

Note the following:

 WARNING
Siemens products may only be used for the applications described in the catalog and in the relevant technical documentation. If products and components from other manufacturers are used, these must be recommended or approved by Siemens. Proper transport, storage, installation, assembly, commissioning, operation and maintenance are required to ensure that the products operate safely and without any problems. The permissible ambient conditions must be complied with. The information in the relevant documentation must be observed.

Trademarks

All names identified by ® are registered trademarks of Siemens AG. The remaining trademarks in this publication may be trademarks whose use by third parties for their own purposes could violate the rights of the owner.

Disclaimer of Liability

We have reviewed the contents of this publication to ensure consistency with the hardware and software described. Since variance cannot be precluded entirely, we cannot guarantee full consistency. However, the information in this publication is reviewed regularly and any necessary corrections are included in subsequent editions.

Table of contents

1	Introduction	5
1.1	Operating instructions scope	5
2	Safety notes	6
2.1	Safety marking symbols.....	6
3	Description	7
3.1	SITRANS LPS200 Overview	7
3.2	Features	7
4	Applications	8
5	Installing/mounting	9
5.1	Food grade material.....	10
5.2	Ambient temperature (housing)/process temperature	11
5.3	Process cautions.....	12
5.4	Sensitivity	13
6	Connection	14
6.1	Universal voltage, DPDT, fail-safe	15
6.2	AC or DC version, SPDT	16
6.3	Switching logic (universal voltage, DPDT).....	17
6.4	Signal output: delay (universal voltage, DPDT)	18
6.5	Alarm output - fail-safe option (universal voltage, DPDT)	19
6.6	Switching logic (AC or DC version, SPDT)	20

7	Service and maintenance	21
7.1	Maintenance.....	21
7.2	Unit repair and excluded liability	21
8	Technical data	22
8.1	Power	22
8.2	Performance.....	23
8.3	Alarm output.....	23
8.4	Mechanical	24
8.5	Environmental	25
8.6	Process	26
8.7	Approvals	27
9	Dimension drawings	28
9.1	Dimensions and temperature ranges.....	28
9.2	Extensions.....	30
9.3	Measuring vanes.....	31
A	Technical reference	32
A.1	Principle of operation	32
B	Certificates and support	33
B.1	Technical support.....	33
B.2	Certificates	33

Introduction

Note









- Please follow the installation and operating procedures for a quick, trouble-free installation and to ensure the maximum accuracy and reliability of your device.
 - This manual applies to SITRANS LPS200 only.
-

1.1 Operating instructions scope

This manual will help you set up your device for optimum performance.

Safety notes

2.1 Safety marking symbols

In manual	On product	Description
		earth (ground) terminal (shield)
		protective conductor terminal
		Dispose of in an environmentally safe manner, and according to local regulations.
		WARNING: refer to accompanying documents (manual) for details.
		CAUTION: Observe electrostatic discharge precautions prior to handling electronic components within the wiring compartment.

Description

Note

- Installation, maintenance, and commissioning must be performed by qualified technical personnel.
 - The device must be used only in the manner outlined in this instruction manual.
 - This product is intended for use in industrial areas. Operation of this equipment in a residential area may cause interference to several frequency-based communications.
-

3.1 SITRANS LPS200 Overview

The device rotating paddle switch is used for level monitoring of bulk materials. It can be used to detect full, demand, or empty conditions in silos, hoppers, or storage vessels of materials such as grain, feed, cement, plastic granulate, and wood chips. The paddle switch measures bulk densities as low as 100 g/l (6.2 lb/ft³) with the standard measuring vane, 35 g/l (2.2 lb/ft³) with the optional hinged vane, or 15 g/l (0.9 lb/ft³) with the optional rectangular vane.

3.2 Features

- High integrity mechanical seal.
- AC, DC, or universal power supply.
- Unique friction clutch mechanism. When the measuring vane encounters sudden resistance, the friction clutch slips to prevent internal component damage.
- Optional fail-safe function alarms on fault conditions or component failure.
- Rotatable enclosure.
- Optional vanes for use with high and low bulk densities to 15 g/l (0.9 lb/ft³).
- Compact, rigid extension (top mounted only), angled rigid extension, and cable extension configurations available.
- High temperature and high pressure models available.
- Optional extension kit available for the compact version.

Applications

- Grain, feed, cement, plastic granulate, wood chips, rice, soybeans, etc.
- Low or high bulk density materials.

Installing/mounting

Note

- Installation shall be performed by qualified personnel and in accordance with local governing regulations.
 - For heavy material, only top mounting of paddle switch is recommended.
 - Compact SITRANS LPS200 is recommended for side mounting on bins for low or intermediate levels.
 - For SITRANS LPS200 Cable extension, the maximum pull force of the rope must not exceed 4 kN (28 kN with reinforced option).
 - When installing LPS200 with rigid extension kit, ensure product is top mounted and never side or angle mounted.
-

 WARNING

This product is designated as a Pressure Accessory per Directive 97/23/EC and is not intended for use as a safety device.

 WARNING

Improper installation may result in loss of process pressure.

The device is normally mounted into the vessel top (full detector) or through the tank wall at the detection level (full, demand or empty detector). The device can be installed through a standard 1¼" NPT or 1½" BSPT pipe coupling, depending on the chosen process thread.

5.1 Food grade material

The materials are available for use under normal and predictable applications (according to directive 1935/2004 Art. 3). Other conditions can influence safety.

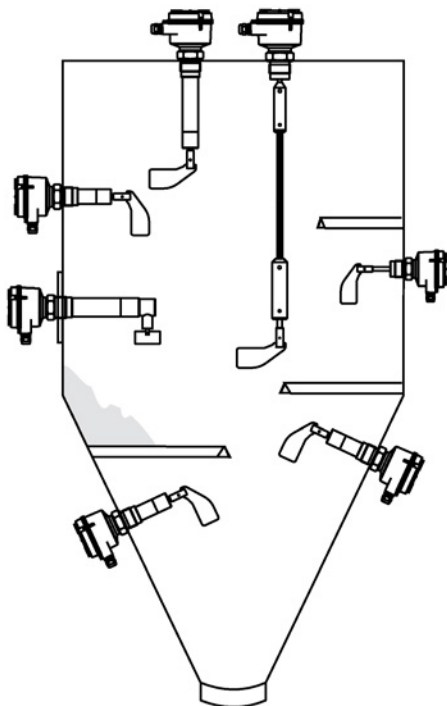

After mounting and as a precaution against water ingress into the housing, turn the housing clockwise until the cable entries point downward.

Note

- Ensure measuring vane is out of any region that is susceptible to build-up.
 - For heavy material loads and protection against falling material, provide angled protection.
 - Ensure cable gland faces downward to avoid water intrusion.
-

5.2 Ambient temperature (housing)/process temperature

-40 °C (-40 °F) ambient and process temperature for version with heating of housing

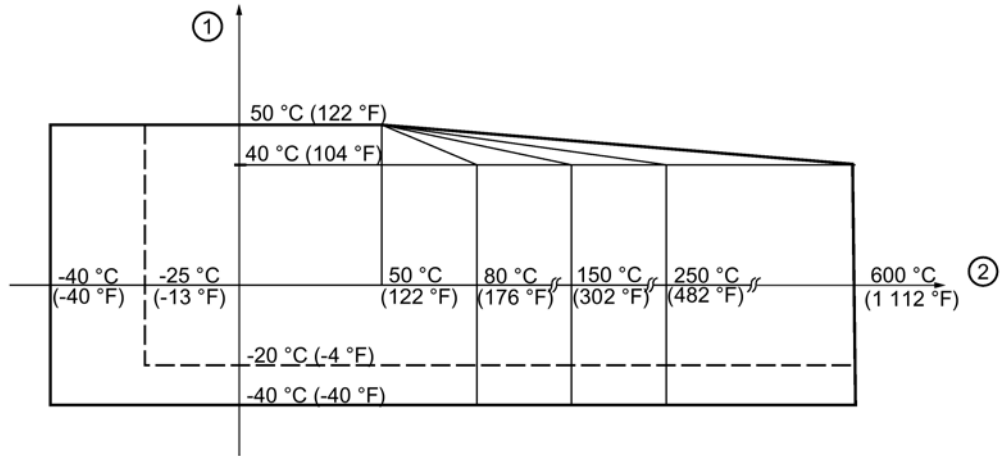

- ① T amb.
- ② T process

5.3 Process cautions

⚠ CAUTION

Keep the device out of the path of falling material.

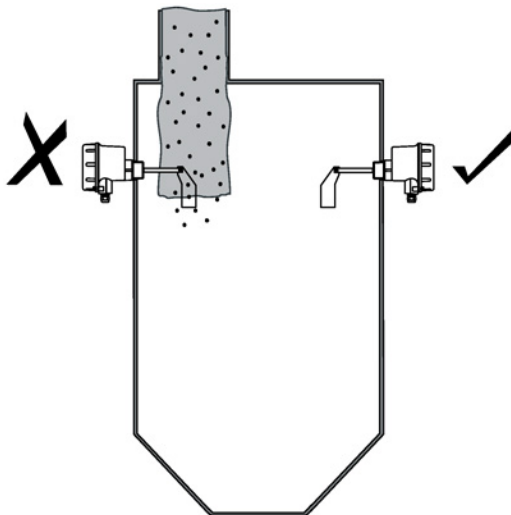

⚠ CAUTION

Protect shaft and measuring vane from falling material.

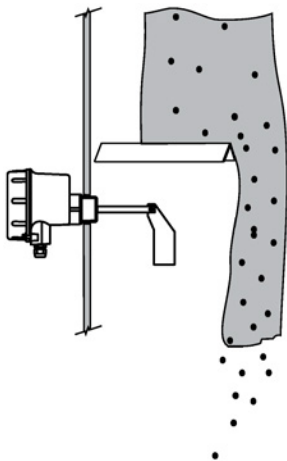

5.4 Sensitivity

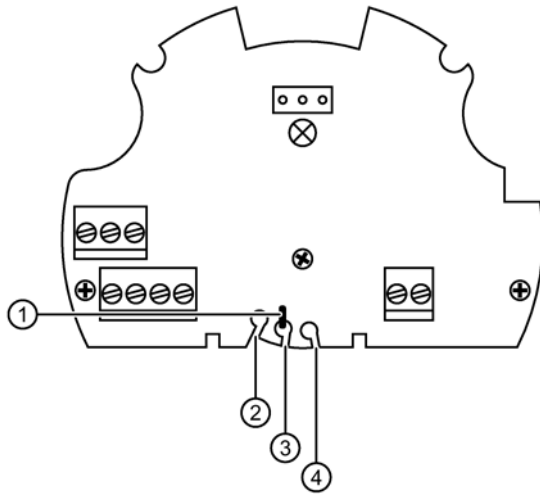

- ① Sensitivity spring
- ② High
- ③ Medium
- ④ Low

Universal voltage version shown.

To adjust the sensitivity of the device, use pliers to move the sensitivity spring to the appropriate position (factory setting is medium). The optional measuring vanes can also improve sensitivity.

 **WARNING**

- Open device only when supply voltage is switched off.
- For switch-selectable voltage version, select correct voltage using manual voltage jumper before switching on the power supply.

Note

- All field wiring must have insulation suitable for at least 250 V AC.
- A disconnect switch shall be in close proximity to the equipment and within easy reach of the operator.
- Unused cable conduit fittings must be locked with a closing element or plug.
- Commissioning must be done only with a closed device.
- Observe all pertinent rules and regulations of the country of installation.

European standards

- **Cable glands and conduit system for ATEX IECEx (Dust and Gas Hazardous Locations):**
Installation according to the regulations of the country where the unit is installed. Not used entries have to be closed with blanking elements certified for this purpose. Where available, factory provided parts must be used.
A strain relief must be provided for the field wiring cables, when the device is installed with the factory provided cable glands.
The diameter of the field wiring cable must match to the clamping range of the cable clamp. If parts other than the factory provided parts are used, the following must be ensured:
The parts must have an approval adequate to the approval of the level sensor (certificate and type of protection). The approved temperature range must be from the minimum ambient temperature of the level sensor to the maximum ambient temperature of the level sensor increased by 10K.
The parts must be mounted according to the instructions of the supplier.
 - **Conduit system for FM and CSA (Dust and Gas Hazardous Locations):**
General requirements: In addition, the regulations of the country must be observed. The used flameproof seals and blanking elements must have an adequate type approval and a temperature range of at least -40 to 80 °C (-40 to 176 °F). In addition, they shall be suitable for the conditions and correctly installed. Where available, the provided original parts of the manufacturer must be used.
-

Note

- Before opening the lid, ensure there are no dust deposits around the device. Ensure that the atmosphere around the device is settled.
 - Use a fuse for the signal output and power supply (max. 10 A, fast or slow, HBC, 250 V).
 - Make sure the main voltage does not exceed the maximum voltage listed on the product label and the setting of the voltage selector.
 - In case of inexpert handling or handling malpractice, the electric safety of the device cannot be guaranteed.
 - Provide protection for relay contacts to protect the device against spikes if inductive loads are connected.
-

6.1 Universal voltage, DPDT, fail-safe

Power supply:

24 V DC $\pm 15\%$ ¹⁾ max. 4 W 22 ... 230 V
50/60 Hz $\pm 10\%$ ¹⁾ max. 10 VA External fuse:
max. 10A, fast or slow, HBC, 250 V

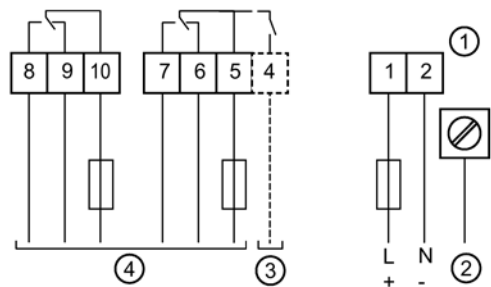
**Signal and alarm output:**

Relay DPDT contact
max. 250 V AC, 5A non-inductive
max. 30 V DC, 4A, non-inductive
External fuse: max. 10A, fast or
slow, HBC, 250 V

① Max. 4 mm² (AWG12)

② PE

③ Fail-safe²⁾

④ Signal output DPDT

¹⁾ Including $\pm 10\%$ of EN 61010-1.

²⁾ With fail-safe option, contact is open when de-energized.

6.2 AC or DC version, SPDT

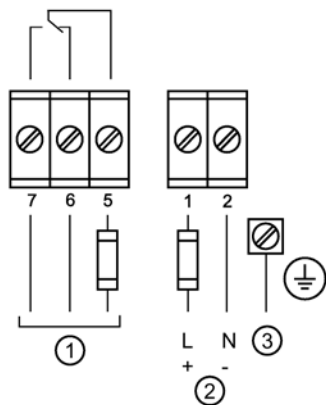

- ① Signal output
- ② 24 V or 48 V or 115 V or 230 V AC $\pm 10\%$
50/60 Hz, 4 VA
or
24 V DC, 2.5 W $\pm 15\%$ ¹⁾
- ③ PE

¹⁾ Including 10 % of EN 61010.

6.3 Switching logic (universal voltage, DPDT)

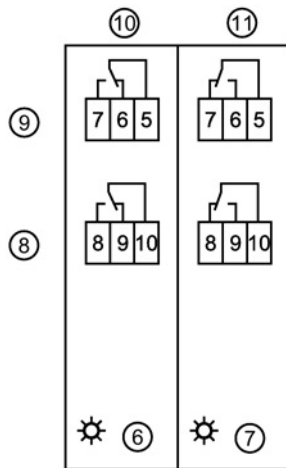
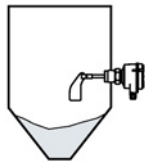

FSH:

Use this setting when sensor is used as a full detector.

Power failure or line break is regarded as "full" signal (protection against overfilling).

FSL:

Use this setting when sensor is used as an empty detector.

Power failure or line break is regarded as "full" signal (protection against overfilling).

Factory setting: FSL

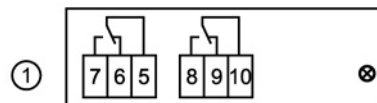
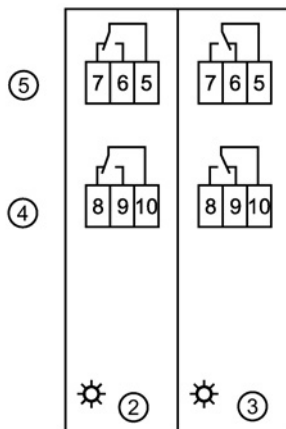
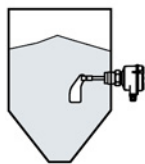

- | | |
|-----------------|---------|
| ① Power failure | ⑦ Green |
| ② Green | ⑧ DPDT |
| ③ Yellow | ⑨ SPDT |
| ④ DPDT | ⑩ FSL |
| ⑤ SPDT | ⑪ FSH |
| ⑥ Yellow | |

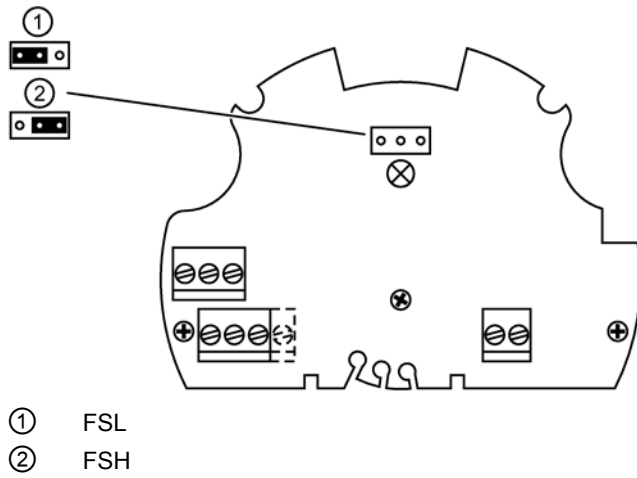

6.4 Signal output: delay (universal voltage, DPDT)

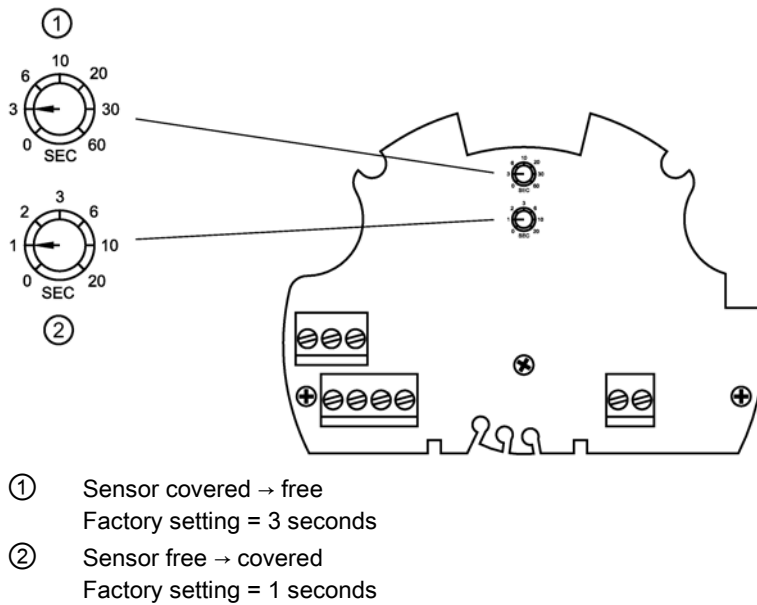

6.5 Alarm output - fail-safe option (universal voltage, DPDT)

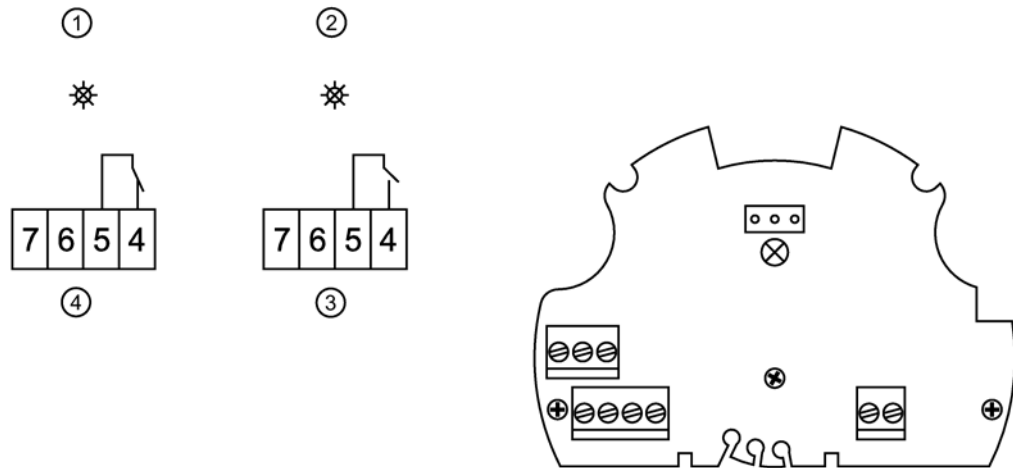

- ① Yellow or green
- ② Red
- ③ Fault
- ④ No fault

Switching and timing behavior: If the vane is not covered, the rotating vane shaft will send pulses at 20 second intervals. In case of fault, the pulses are missed. After 30 seconds, the alarm relay will open.

Connection example:

Full detector with maximum safety:
The output signal opens in case of:

- Full signal, or
- Failure of supply voltage, or
- Defect of the connection wires, or
- Defective unit

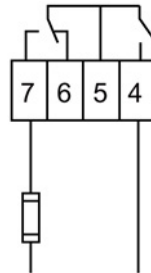

6.6 Switching logic (AC or DC version, SPDT)

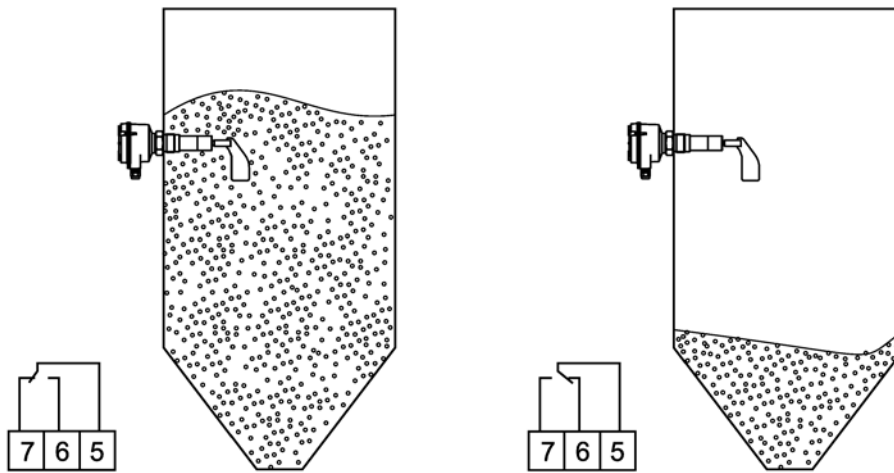

Service and maintenance

7.1 Maintenance

This device requires no maintenance or cleaning under normal operating conditions. Under severe operating conditions, the measuring vane may require periodic cleaning. Brush off any accumulated deposits, taking care not to bend the vane.

7.2 Unit repair and excluded liability

All changes and repairs must be done by qualified personnel, and applicable safety regulations must be followed. Please note the following:

- The user is responsible for all changes and repairs made to the device.
- All new components must be provided by Siemens.
- Restrict repair to faulty components only.
- Do not re-use faulty components.

Note

Siemens makes every attempt to ensure the accuracy of these specifications but reserves the right to change them at any time.

8.1 Power

	<ul style="list-style-type: none">• 24V, 48 V, 115 V, or 230 V \pm 10 %¹⁾ 50/60 Hz, 4 VA• 22 ... 230 V AC, \pm 10 % 50/60 Hz, 10 VA• 24 V DC, \pm 15 %¹⁾ 2.5 W
--	---

¹⁾ All voltages, including \pm 10 % according to IEC 61010-1.

8.2 Performance

Alarm delay	
• 1 rpm model (storage applications)	Approx. 1.3 s
• 5 rpm model (process applications)	Approx. 0.26 s
Sensitivity	
	<ul style="list-style-type: none"> Adjustable spring tension position Optional measuring vanes available, depending on customer sensitivity requirements
Approximate minimum material density	
• Standard measuring vane	<ul style="list-style-type: none"> 100 g/l (6.2 lb/ft³) when vane is covered by 10 cm (4 inch) of material 200 g/l (12.5 lb/ft³) when vane is covered by more than 10 cm (4 inch) of material
• Hinged measuring vane	<ul style="list-style-type: none"> 35 g/l (2.2 lb/ft³) when vane is covered by 10 cm (4 inch) of material 70 g/l (4.4 lb/ft³) when vane is covered by more than 10 cm (4 inch) of material
• Rectangular measuring vane (98 x 250 mm)	<ul style="list-style-type: none"> 15 g/l (0.9 lb/ft³) when vane is covered by 10 cm (4 inch) of material 20 g/l (1.2 lb/ft³) when vane is covered by more than 10 cm (4 inch) of material See Measuring vanes (Page 31) for more information.

8.3 Alarm output

	<ul style="list-style-type: none"> Microswitch or relay SPDT or DPDT contact 5 A at 250 V AC, non-inductive Microswitch or relay SPDT or DPDT contact 4 A at 30 V DC, non-inductive
--	---

8.4 Mechanical

Process connections	
• Threaded connection	1", 1¼", 1½" NPT or 1", 1¼", 1½" BSP material: stainless steel 303 (1.4305) or 316L (1.4404), optional aluminum
• Flanged connection	DN 32 PN 6, DN 100 PN 6, DN 100 PN 16, 2", 3", 4" ASME, 150 lb, B 16.5 (1.4541/321)
• Tri-clamp	2" DN 50 ISO 2852
Enclosure	
• Construction	Epoxy coated aluminum
• Conduit entry	2 x M20 x 1.5, or 2 x ½" NPT
• Ingress protection	Type 4X/NEMA 4X/IP66
• Vane and shaft construction	Stainless steel 304 and 303 (1.4301 and 1.4305) or 316L (1.4404)
Weight	
• Standard temperature:	
-Compact	1.8 kg (4.0 lb)
-Extended	2.2 kg (4.9 lb)
-Angled extended	4.0 kg (8.8 lb)
-Cable	3.2 kg (7.1 lb)
• High temperature	
-Compact	2.6 kg (5.7 lb)
-Extended	3.0 kg (6.6 lb)
-Angled extended	5.2 kg (11.4 lb)
-Cable	4.0 kg (8.8 lb)

8.5 Environmental

• Location	Indoor/outdoor
• Altitude	Max. 2 000 m (6 562 ft)
• Ambient temperature	-25 ... +50 °C (-13 ... +122 °F)
• Relative humidity	0 ... 100 %, suitable for outdoor (ingress protection: Type 4X/NEMA 4X/IP66)
• Overvoltage category	II
• Pollution degree	2

Note

With the heated enclosure option, the ambient temperature rating improves to -40 ... +50 °C (-40 ... +122 °F).

8.6 Process

Temperature	
• Standard model	
	-25 ... +80 °C (-13 ... +176 °F)
	CSA temperature code: T5
- Maximum surface temperature	120 °C (248 °F) [ATEX relevant]
• High temperature option	
- CE and General Purpose	-25 ... +600 °C (-13 ... +1 112 °F)
- FM/ATEX Hazardous	-25 ... +250 °C (-13 ... +482 °F)
- CSA Class II Group E, F	-25 ... +195 °C (-13 ... +383 °F), CSA temperature code: T2D
- CSA Class II Group G	-25 ... +160 °C (-13 ... +320 °F), CSA temperature code: T3B
- Maximum surface temperature	250 °C (482 °F)
Pressure	
• Standard model	Max. 0.8 bar, gauge (11.6 psi, gauge)
• High pressure options	Max. 5 bar, gauge (72.5 psi, gauge)
	Max. 10 bar, gauge (145 psi, gauge)

Note

The device construction allows over-pressure between -0.2 and 0.1 bar in hazardous areas.

WARNING

This product is designated as a Pressure Accessory per Directive 2014/68/EU and is not intended for use as a safety device.

WARNING

Materials of construction are chosen based on their chemical compatibility (or inertness) for general purposes. For exposure to specific environments, check with chemical compatibility charts before installing.

8.7 Approvals

Note

See product name plate for approval details.

	<ul style="list-style-type: none">• FM/CSA Class II, Div. 1, Group E, F, G, Class III• ATEX II ½ D (dust explosion)• IECEx t IIIC Da/Db• CE• RCM• FM/cCSA_{US} General Purpose (see product nameplate for approval details)• Food grade material (according to directive 1935/2004/EC) <i>Food grade material in contact with the process food (sealing and grease FDA. conform). The option does not automatically implement a food conform design (food conform gaps, surface and radiuses).</i>
--	--

Dimension drawings

9.1 Dimensions and temperature ranges

Standard Model

Compact version	Extended	Angle extension	Rope option

Dimensions in mm (inch)

① Conduit connection M20 or ½" NPT ② Measuring vane ③ Process temperature -25 ... +80 °C (-13 ... +176 °F) ④ Thread length BSP: 20.5 mm (0.81 inch) NPT: 24 mm (0.94 inch) ⑤ Zone 20 (ATEX Category 1D IECEx EPL Da) ⑥ Zone 21 (ATEX Category 2D IECEx EPL Db) ⑦ Ambient temperature: -25 ... +50 °C (-13 ... +122 °F)	L = length		① 125 ... 300 mm (4.92 ... 8.46 inch)	① Rope fixing ② 2 000 mm (78.74 inch) standard, can be shortened by the customer, total length available 10 000 mm (393.7 inch)
	100 mm	3.94 inch		
	150 mm	5.91 inch		
	200 mm	7.87 inch		
	250 mm	9.84 inch		
	300 mm	11.81 inch		

1) For 35 x 106 mm boot-shaped, and 65 x 210 mm hinged measuring vanes, add 16 mm (0.63 inch) to extension length.

High temperature model

Compact version	Extended	Angle extension	Rope option
<p>① Process temperature³⁾ -25 ... +600 °C (-13 ... +1 112 °F)</p> <p>② Zone 20 (ATEX Category 1D IECEx EPL Da)</p> <p>③ Zone 21 (ATEX Category 2D IECEx EPL Db)</p> <p>④ Thread length BSP: 20.5 mm (0.81 inch) NPT: 24 mm (0.94 inch)</p> <p>⑤ Ambient temperature: -25 ... +50 °C (-13 ... +122 °F)</p>	L = length		<p>① 125 ... 300 mm (4.92 ... 8.46 inch)</p> <p>① Rope fixing</p> <p>② 2 000 mm (78.74 inch) standard, can be shortened by the customer, total length available 10 000 mm (393.7 inch)</p>
	100 mm	3.94 inch	
	150 mm	5.91 inch	
	200 mm	7.87 inch	
	250 mm	9.84 inch	
300 mm	11.81 inch		

Note

- For heavy material, only top mounting of paddle switch is recommended.
- Compact LPS200 is recommended for side mounting on bins for low or intermediate material levels.

¹⁾ For 35 x 106 mm boot-shaped, and 65 x 210 mm hinged measuring vanes, add 16 mm (0.63 inch) to extension length.

²⁾ A = 200 mm (7.87 inch) for 250 °C (482 °F) = 400 mm (15.74 inch) for 600 °C (1 112 °F).

³⁾ For use with all approval options except CSA Class II. See Temperature (Page 26) more details.

9.2 Extensions

Standard model: tri-clamp

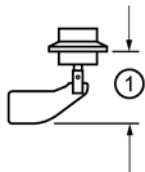

① 70 ... 1 500 mm (2.76 ... 59 inch)

High temperature model: temperature extended shaft

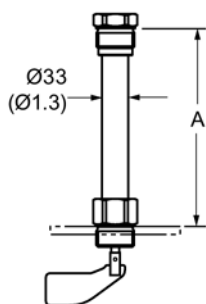

Process temperature	A
150/250 °C (302/482 °F)	200 mm (7.87 inch)
350 °C (662 °F)	350 mm (11.8 inch)
600 °C (1 112 °F)	400 mm (15.7 inch)

9.3 Measuring vanes

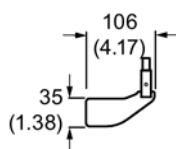
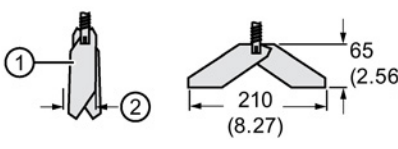
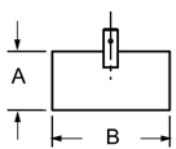
Standard	Hinged	Rectangular
		
Dimensions in mm (inch)		
① Fold together to lead into mounting hole ② Min. 37 mm (1.46 inch)		

Vane	Vane completely covered with bulk material		Bulk material covers the vane up to 10 cm (3.93 inch)		Rectangular vane options	
	Spring Adjustment		Spring Adjustment		A	B
	Light	Central (factory setting)	Light	Central (factory setting)		
Boot shaped 35 x 106 mm	200 g/l (12.5 lb/ft ³)	300 g/l (18.7 lb/ft ³)	100 g/l (6.2 lb/ft ³)	150 g/l (9.4 lb/ft ³)	50 mm (1.97 inch)	98 mm (3.86 inch)
Boot shaped 28 x 98 mm	300 g/l (18.7 lb/ft ³)	500 g/l (31.2 lb/ft ³)	150 g/l (9.4 lb/ft ³)	150 g/l (9.4 lb/ft ³)	50 mm (1.97 inch)	150 mm (5.90 inch)
Rectangular 50 x 98 mm	300 g/l (18.7 lb/ft ³)	500 g/l (31.2 lb/ft ³)	150 g/l (9.4 lb/ft ³)	250 g/l (15.6 lb/ft ³)	50 mm (1.97 inch)	250 mm (9.84 inch)
Rectangular 50 x 150 mm	80 g/l (5.0 lb/ft ³)	120 g/l (7.5 lb/ft ³)	40 g/l (2.5 lb/ft ³)	60 g/l (3.7 lb/ft ³)	98 mm (3.86 inch)	150 mm (5.90 inch)
Rectangular 50 x 250 mm	30 g/l (1.9 lb/ft ³)	50 g/l (3.1 lb/ft ³)	15 g/l (0.9 lb/ft ³)	25 g/l (1.6 lb/ft ³)	98 mm (3.86 inch)	250 mm (9.84 inch)
Rectangular 98 x 150 mm	30 g/l (1.9 lb/ft ³)	50 g/l (3.1 lb/ft ³)	15 g/l (0.9 lb/ft ³)	25 g/l (1.6 lb/ft ³)		
Rectangular 98 x 250 mm	20 g/l (1.2 lb/ft ³)	30 g/l (1.9 lb/ft ³)	15 g/l (0.9 lb/ft ³)	15 g/l (0.9 lb/ft ³)		
Hinged 65 x 210 mm	70 g/l (4.4 lb/ft ³)	100 g/l (6.2 lb/ft ³)	35 g/l (2.2 lb/ft ³)	50 g/l (3.1 lb/ft ³)		
Hinged 60 x 200 mm	70 g/l (4.4 lb/ft ³)	100 g/l (6.2 lb/ft ³)	35 g/l (2.2 lb/ft ³)	50 g/l (3.1 lb/ft ³)		

Technical reference

A.1 Principle of operation

A low revolution gearing motor drives a rotating measuring vane. When material reaches the rotating vane, rotation stops, actuating a switch. When the vane is no longer covered, rotation resumes and the switch reverts to its normal condition.

The synchronous induction motor is freely suspended within the housing. When the rotation is slowed by the material, the reaction torque is used to operate a switch that gives an electrical signal to stop the motor. When the material level moves away from the rotating vane, a spring draws the motor back into operating position, the switch returns to operating position, and the motor is switched back on.

Two motor speeds are available:

- 1 rpm, for storage silos
- 5 rpm, for faster process requirements

Certificates and support

B.1 Technical support

Technical support

If this documentation does not provide complete answers to any technical questions you may have, contact Technical Support at:

- Support request (<http://www.siemens.com/automation/support-request>)
- More information about our Technical Support is available at Technical Support (<http://www.siemens.com/automation/csi/service>)

Internet Service & Support

In addition to our documentation, Siemens provides a comprehensive support solution at:

- Service and Support (<http://www.siemens.com/automation/service&support>)

Personal contact

If you have additional questions about the device, please contact your Siemens personal contact at:

- Partner (<http://www.automation.siemens.com/partner>)

To find the personal contact for your product, go to "All Products and Branches" and select "Products & Services > Industrial Automation > Process Instrumentation".

Registered business address: Siemens AG, DE-76181, Karlsruhe, Germany

Documentation

You can find documentation on various products and systems at:

- Instructions and manuals (<http://www.siemens.com/processinstrumentation/documentation>)

B.2 Certificates

You can find certificates on the Internet at Certificates (<http://www.siemens.com/processinstrumentation/certificates>) or on an included DVD.