

V100 & V110 Compression Fitting

The Most Accurate and Reliable Technology for Measuring Gas, Liquid and Steam...

Developed from aerospace technology, the VERIS Verabar® averaging pitot flow sensor provides unsurpassed accuracy and reliability.



V100

With its solid, one-piece construction and bullet shape, the VERIS Verabar® makes flow measurement leak resistant and precise. The unique sensor shape reduces drag and flow induced vibration. The location of the low-pressure ports significantly reduces the potential for clogging and improves signal stability.



V110

V100 Single Support and V110 Opposite Support	
Pipe Connection	Threaded (NPT)
Mounting Type	Tube fitting
Features and Benefits	<ul style="list-style-type: none"> • Most cost effective model • Installed in less than one hour • Low and medium pressures
Applications	<ul style="list-style-type: none"> • Pipes (steel, PVC, FRP, copper) • Air (compressed, combustion) • Natural gas • Stack/flue gas • Water (raw, cooling, feedwater) • Low pressure steam • Non-hazardous fluids
Special Designs — Consult Factory	<ul style="list-style-type: none"> • Custom mounting, lengths, materials, instrument connections, etc. • Short straight run

Temperature Pressure Limits (ANSI Class)*
300#
740 psig @ 100°F (51.0 bar @ 38°C)
410 psig @ 800°F (28.3 bar @ 426°C)
600#
1440 psig @ 100°F (99.3 bar @ 38°C)
825 psig @ 800°F (56.9 bar @ 426°C)

Model Specifications	V100 and V110	
Sensor Code	05	10
Sensor Diameter	7/16" (11mm)	7/8" (22mm)
Accuracy	±1% of flow rate; up to +/-0.5% if calibrated	
ANSI Class*	600#	300#
Pipe Size	2" - 6" (50mm-150mm)	6" - 48" (150mm-1200mm)
Instrument Connection	1/2" NPT or Direct Mount	
Components Furnished	Weld coupling, tube fitting; V110 includes additional weld coupling and plug	
Weld Coupling Size	3/4" NPT	1" NPT

* DIN and JIS flanges available. Consult factory.



1. Enter Pipe Dimensions or Duct Dimensions

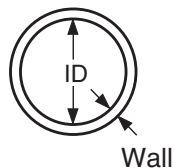

Pipe Size _____ Sch _____
 Pipe ID _____ and
 Wall _____ Pipe Material _____

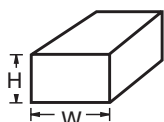

Height (H) _____
 Width (W) _____
 Wall _____
 Duct Material _____

Dimension Verabar® spans (H) or (W)

2. Pipe or Duct Orientation (Check one box)

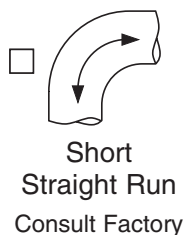
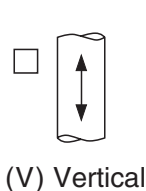
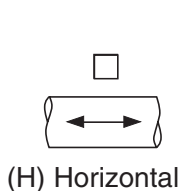

3. Enter Flow Conditions

Fluid Name:		Maximum	Nominal	Minimum	Units
Flow Rate					
All Fluids	Pressure @ Flow				
	Temperature @ Flow				
Gas	Specific Gravity, or Molecular Weight				
Liquid	Specific Gravity				
Steam	VeraCalc Program can calculate Density from Temperature and Pressure				

4. Select Model from Page 3

Use the Ordering Information table on Page 3 to determine your model number.

5. Flow Calculation

All VERIS Verabar® applications require a flow calculation to verify the DP, pressure and temperature limits, structural limits and to size the transmitter. VeraCalc is for use by representatives and end users. It is easy to operate and includes steam tables.

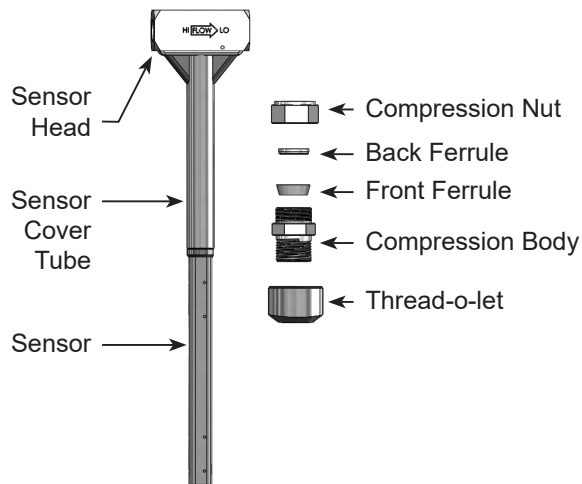

Verabar® Model V100

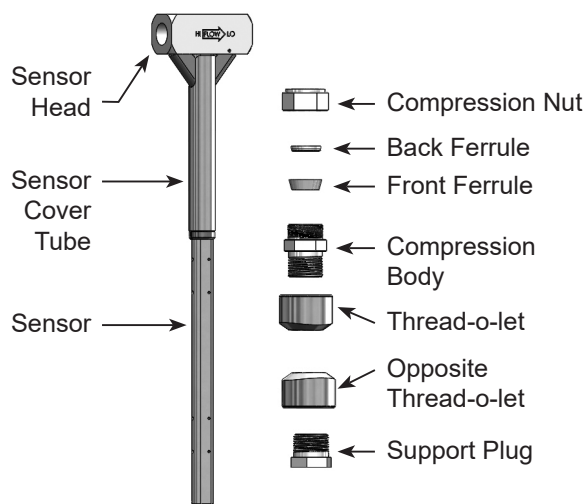

Verabar® Model V110

Model	Regular
V100	Compression Fitting (Single Support)
V110	Compression Fitting (Double Support)

Pipe Size and Schedule or Exact ID and Wall Thickness

Code	Sensor Pipe Size Range
05	2" to 6" (50mm to 150mm)
10	6" to 48" (150mm to 1200mm)

Code	Pipe Orientation
H	Horizontal
V	Vertical

Instrument Connections (Select Remote or Direct Mount) (Transmitter sold separately)						
Remote Mount Transmitter (1/2" NPT)				Direct Mount Transmitter (Flanged 450°F/232°C Max.)†		
Parallel	Regular	RTD*	Valve	Transmount	Mass Transmount	Manifold
			Integral		Integral RTD	Integral
P	R	D	T	F	G	M

Instrument Valves (Opt.)		Manifolds (Optional)			
Remote Mount		Direct Mount			
Needle	Gate	3-Valve		5-Valve	
1/2" NPT	1/2" NPT	Soft Seat	Hard Seat	Soft Seat	Hard Seat
C2NC (CS) C2NS (SS)	C2GC (CS) C2GS (SS)	F3SC (CS) F3SS (SS)	F3HC (CS) F3HS (SS)	F5SC (CS) F5SS (SS)	F5HC (CS) F5HS (SS)

Optional

Code	Options
WNS	For stainless steel pipes. For V100, furnished with one SS weld coupling. For V110, furnished with two SS weld couplings and one SS plug.

V100 8"sch40 10 H R C2NC Typical Model Number

* For high pressure (>500psig) or high temperature (>500°F), remote mount RTD in a thermowell is preferred.
† Assuming adequate heat dissipation for transmitter.

		
VERIS Flow Measurement Group armstronginternational.com/veris		
DATE: 09/20/01	DWG. No. SUB-3934	Rev: A
Scale: NTS		Page 1 of 1

VERIS Verabar®
V100 & V110
Tube Fitting,
Threaded

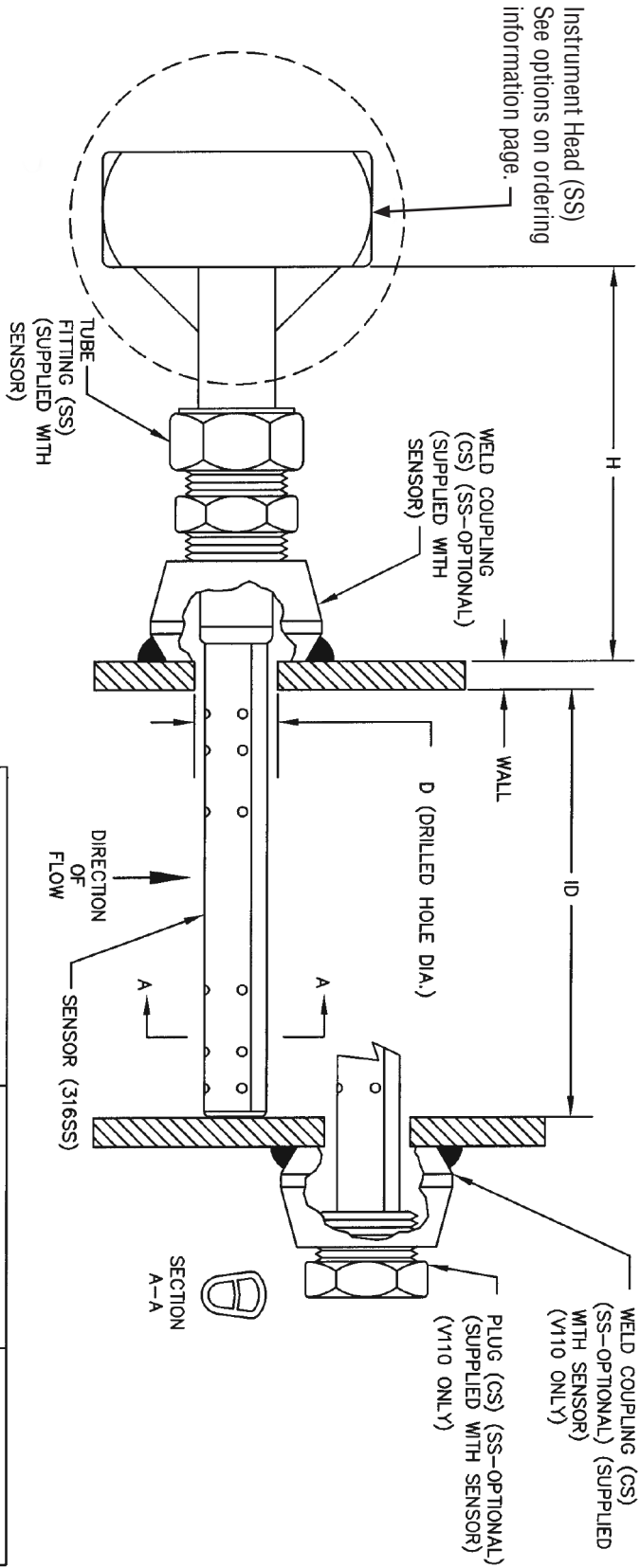

ITEM	SENSOR -05	SENSOR -10
ANSI RATING	CLASS 600#	CLASS 300#
SENSOR DIA.	7/16" (11mm)	7/8" (22mm)
DIM 'D' DRILLED HOLE DIAMETER	1/2" (13mm)	1" (26mm)
FITTING SIZE	5/8" TUBE X 3/4" NPT	1" TUBE X 1" NPT
COUPLING SIZE	3/4" NPT	1" NPT
DIM 'H'	4.0" (102mm)	5.5" (140mm)

Designs, materials, weights and performance ratings are approximate and subject to change without notice.
 Visit armstronginternational.com for up-to-date information.



Armstrong VERIS Flow Measurement Group
 6315 Monarch Park Pl, Niwot, CO 80503 - USA Phone: 303-652-8550 Fax: 303-652-8552
armstronginternational.com